

ENGENS HVILE





DESIGNPRINCIPPER

DE FIRE PARAMETRE

MÅLGRUPPE OG POTENTIALE

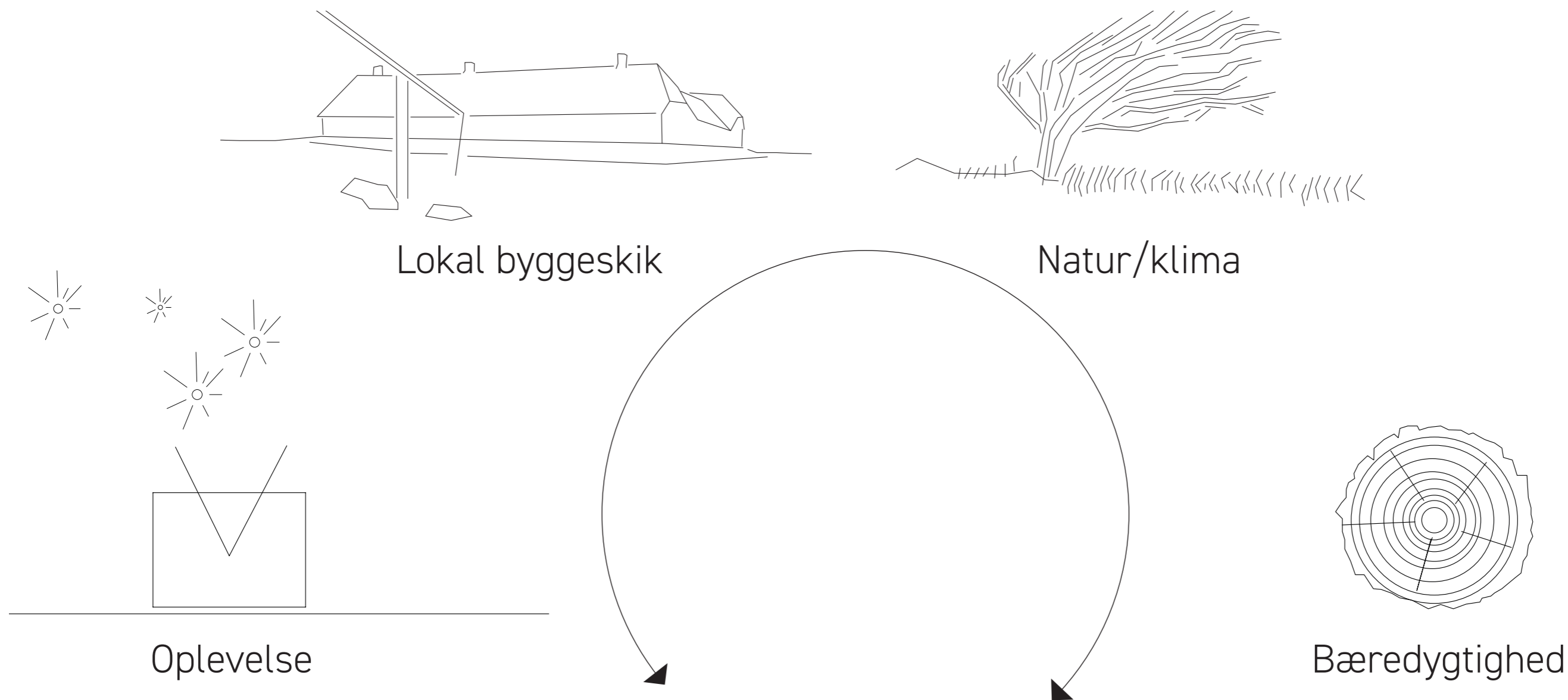

ENGENS HVILE

Arkitektonisk, CO₂-venlig overnatningsenhed
i Destination Vesterhavet

INSPIRATION

HISTORIE, NATUR OG BYGGESKIK



JANDERUP LADEPLADS i Varde Ådal



ABELINES GÅRD ved Hvide Sande

DOMMERGÅRDEN ved Skjern

ANKOMSTEN



HUSET PAKKES UD



PLANLØSNING

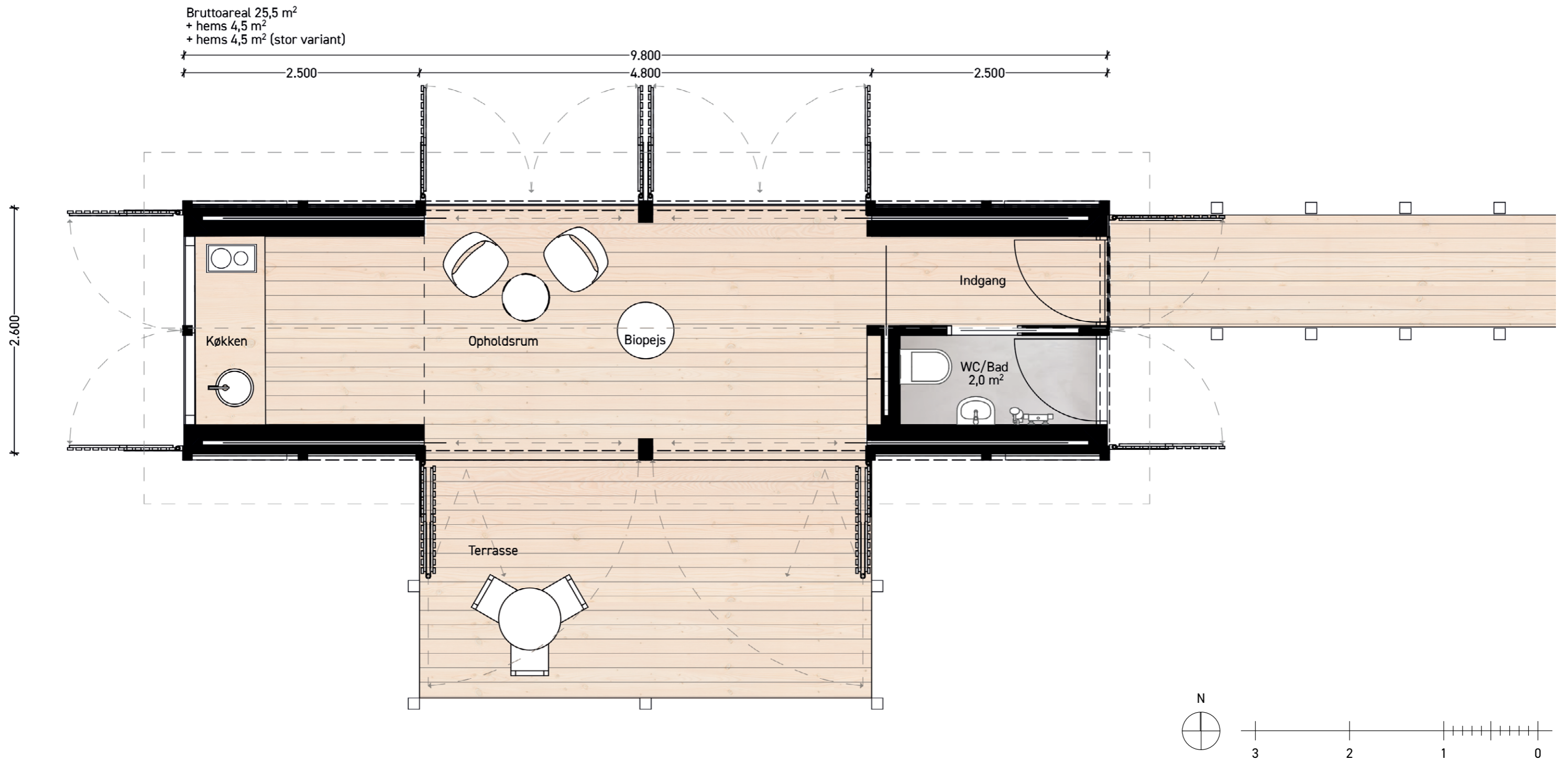

INDVENDIGE OVERFLADER



UDVENDIGE OVERFLADER



BYGGEMATERIALER OG KLIMAAFTRYK



BYGGEMATERIALER OG KLIMAAFTRYK



4 PERSONERS ENHED OG UDVIDELSESMULIGHEDER

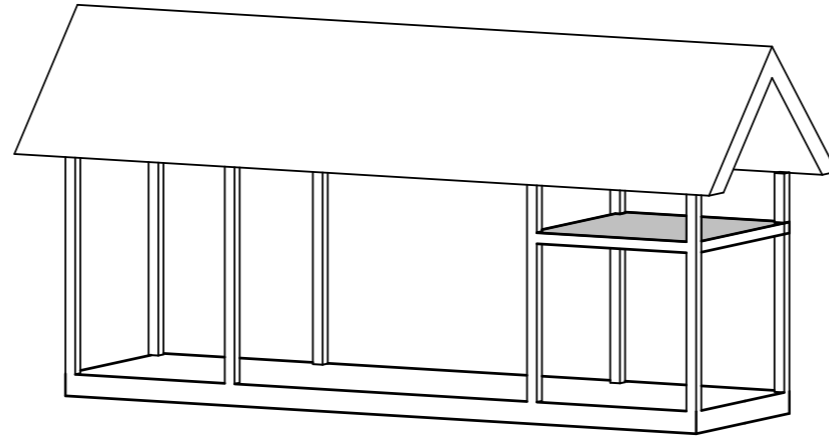

2 sovepladser

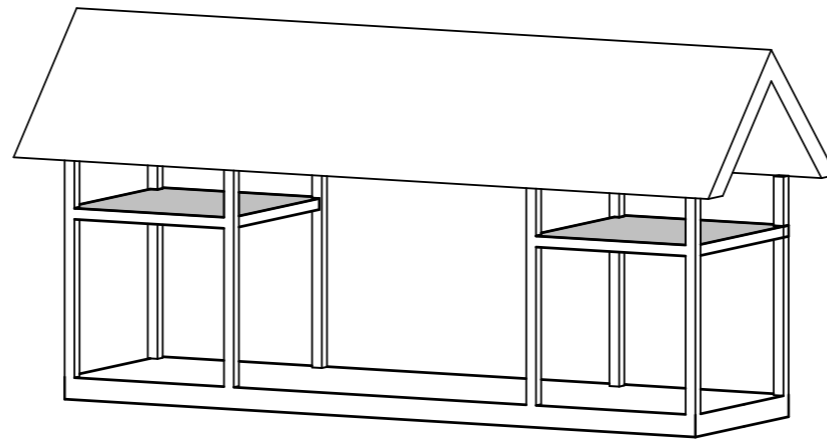

2 x 2 sovepladser

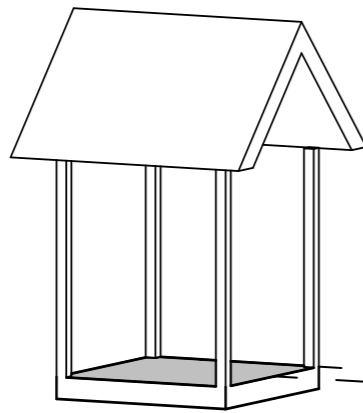

2 tilgængelige
sovepladser

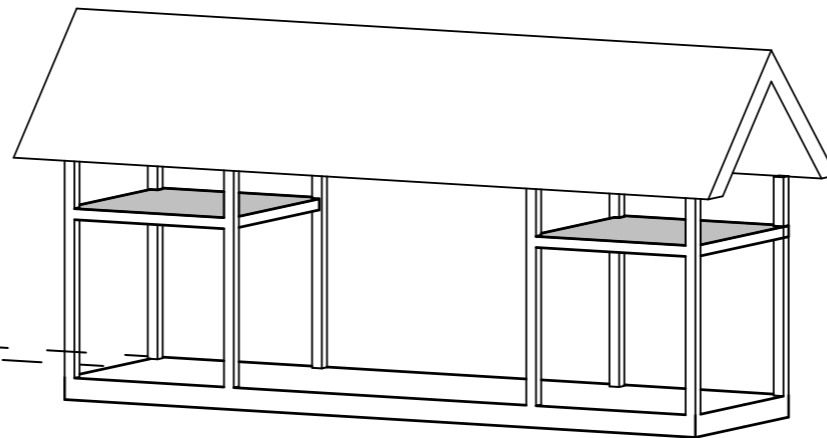

2 x 2 sovepladser

LÆNGDESNIIT - 2 PERSONERS ENHED

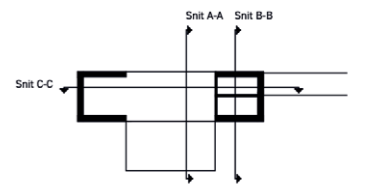

TVÆRSNIT

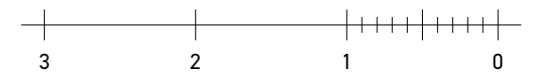
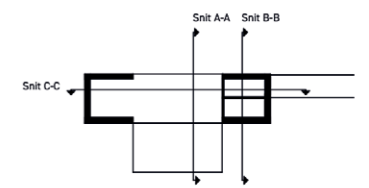
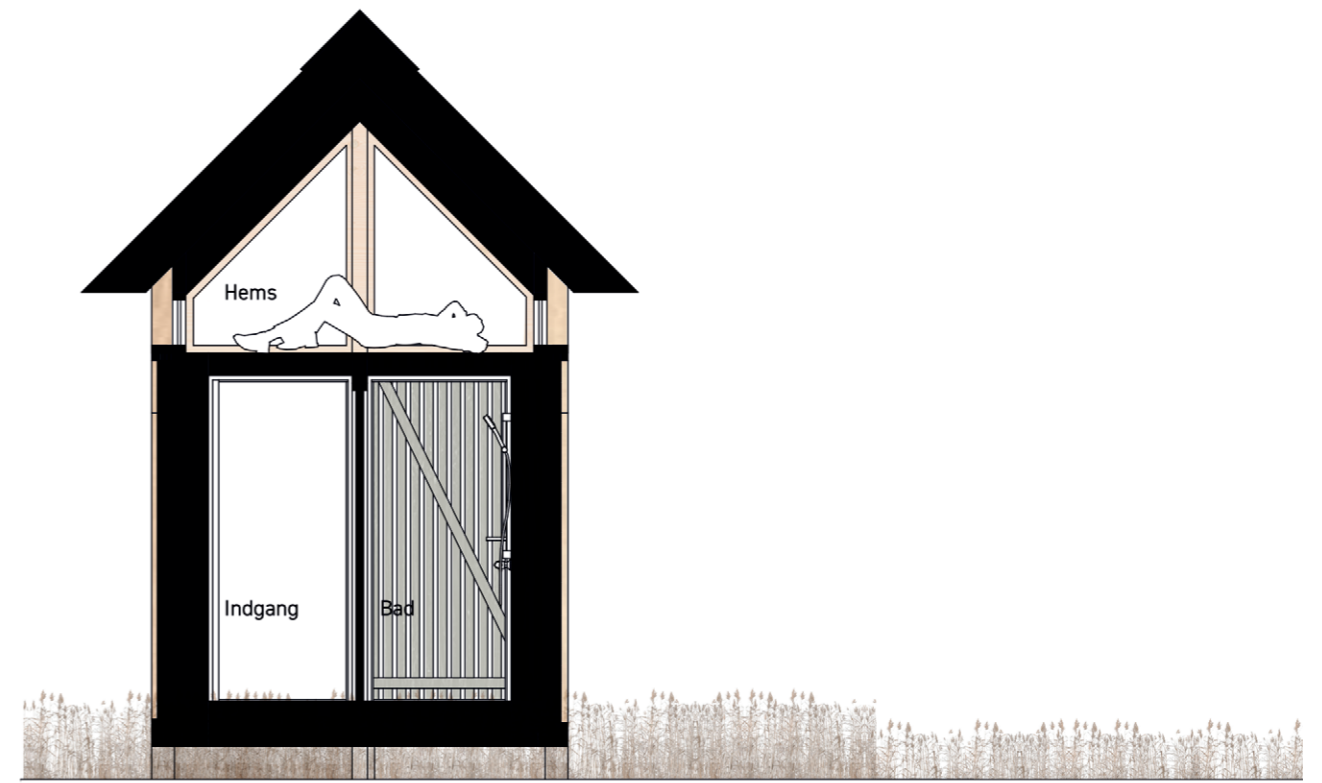
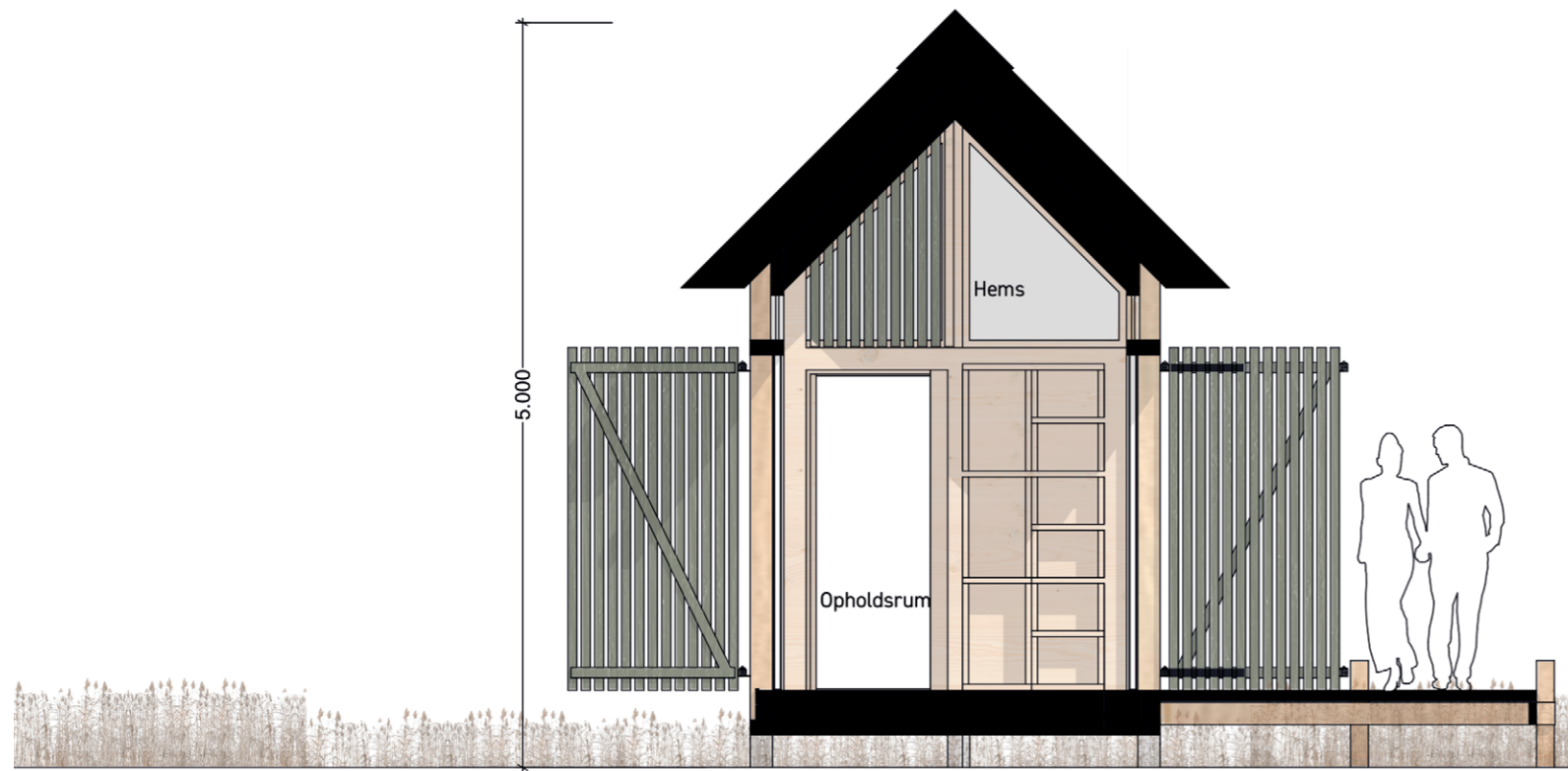

OPSTALT

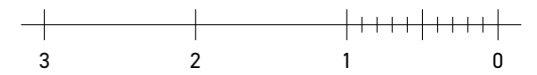
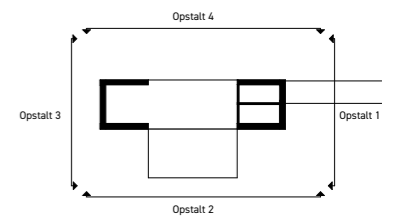
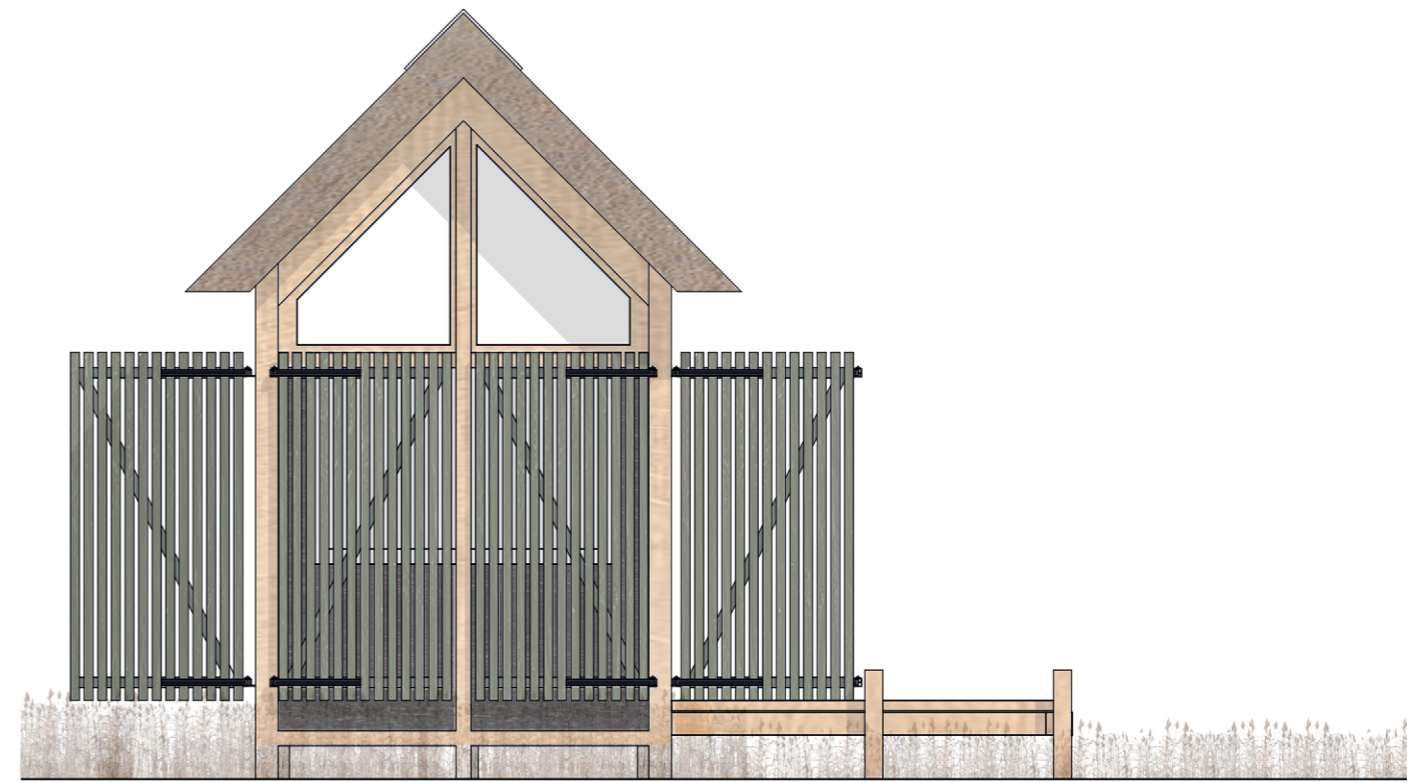
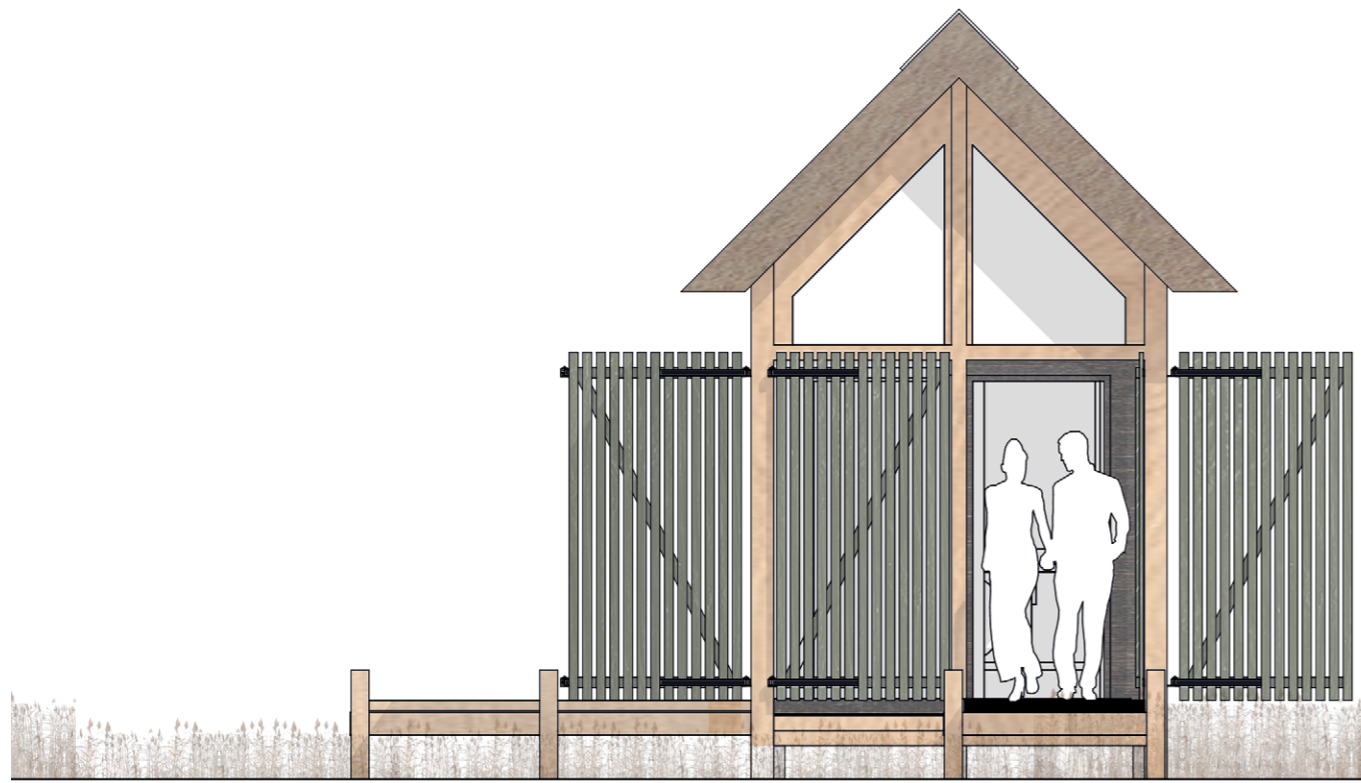

OPSTALT

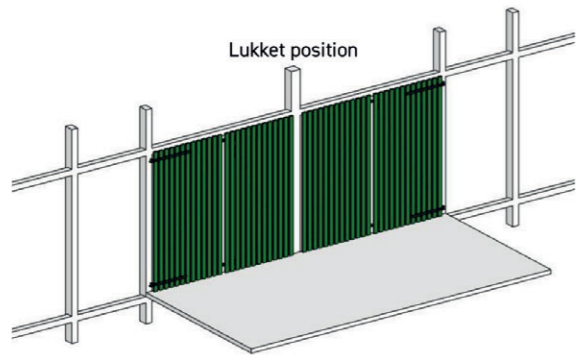

Lukket position

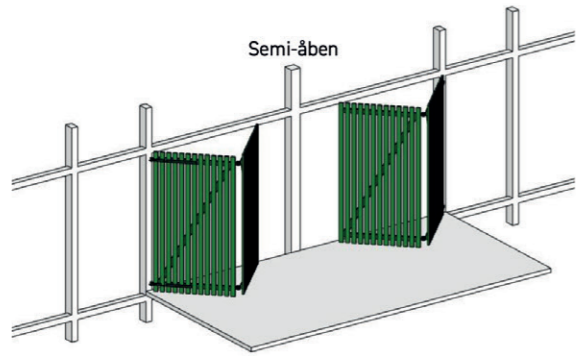

Semi-åben

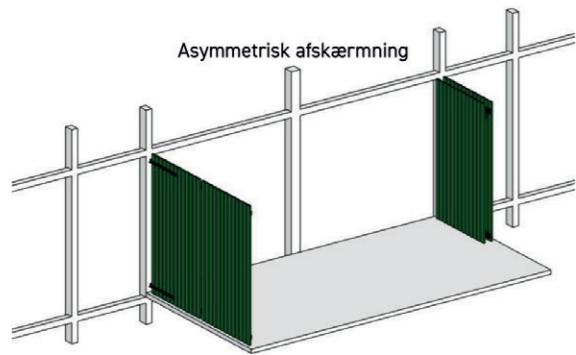

Asymmetrisk afskærmning

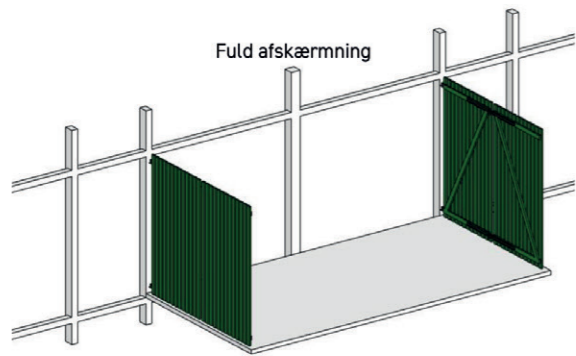

Fuld afskærmning

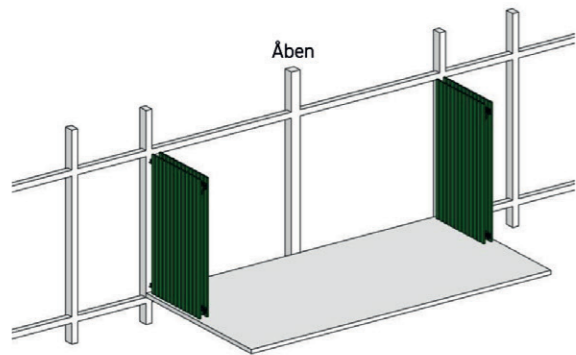

Åben

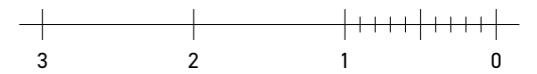
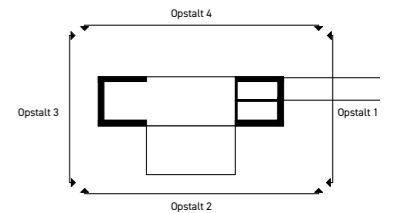
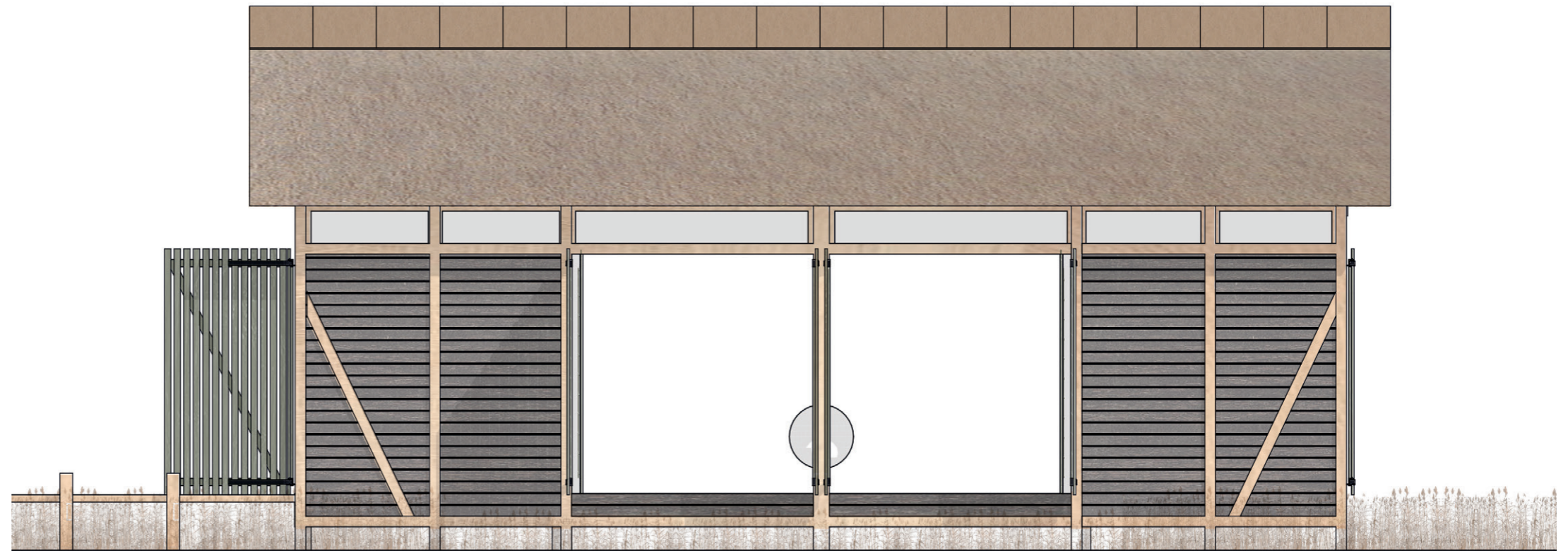

OVERSLAG

2-personers enhed		
Fundamenter	72.000	Kr
Gulv	104.000	Kr
Terrasse/gangbro	60.000	Kr
Ydervægge	285.000	Kr
Vinduer/døre	250.000	Kr
Udvendige porte	120.000	Kr
Hems, dæk	10.000	Kr
Tag	180.000	Kr
Indvendige vægge, inkl døre	25.000	Kr
Vådtrumssikring og fliser	35.000	Kr
VVS	60.000	Kr
El inkl varmepumpe	80.000	Kr
Fast inventar, inkl biopejs	80.000	Kr
Løst inventar	25.000	Kr
Sum total ekskl moms	1.386.000	Kr
Sum total inkl moms	1.732.500	Kr

4 personers enhed		
Tillæg ved 4 personers enhed ekskl moms	75.000	Kr
Tillæg ved 4 personers enhed inkl moms	93.750	Kr

ENGENS HVILE

